

ShelterCoat™

Custom Garage Program

Build your Own All-Season Shelter

Thousands of options to custom fit your storage needs.

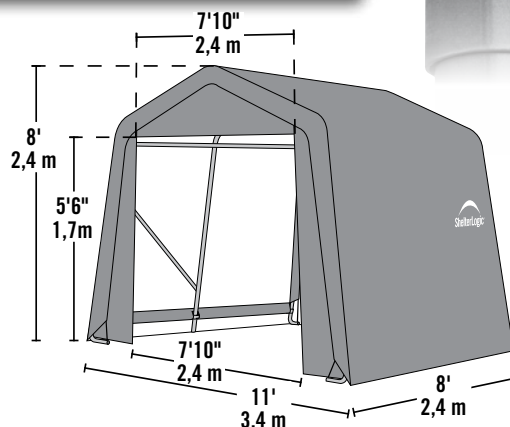

Strong, Sturdy & Durable

- Patented ShelterLock® frame stabilizers at every rib connection for rock-solid strength.
- Frame constructed of heavy duty 1-5/8 in. diameter steel.
- Premium powder coat finish protects frame from corrosion and rust.
- Ripstop-tough advanced engineered polyethylene fabric cover is UV treated inside, outside, and in between.
- Seams are heat welded, not stitched; 100% waterproof.
- Ratchet tensioning system and Easy-Slide cover rails keep the cover smooth and taut.

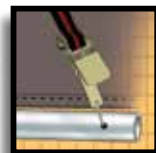

10 x 8 x 8 ft.

Unit Specifications:

- 139.8 lbs. / 63.4 kg Total Weight
- 1-5/8 in. / 4 cm All steel frame
- 15 in. / 38.1 cm Auger anchors
- (2) Double-zippered door panels
- Additional anchors sold separately
- Cover, End Panels and Frame are covered by a 1 year Limited Warranty.

Kit Dimensions:

- Box 1:** 69.5 x 13.8 x 6.3 in.
177 x 35 x 16 cm
- Box 2:** 42.5 x 17.1 x 3.5 in.
108 x 44 x 9 cm

9 oz. per m² Polyethylene

Gray 72803



Green 72804

